

## PCE-AC56 Dual-Band Wireless PCI-E Adapter (For 802.11 a/g/b/n/ac Wireless Networks)

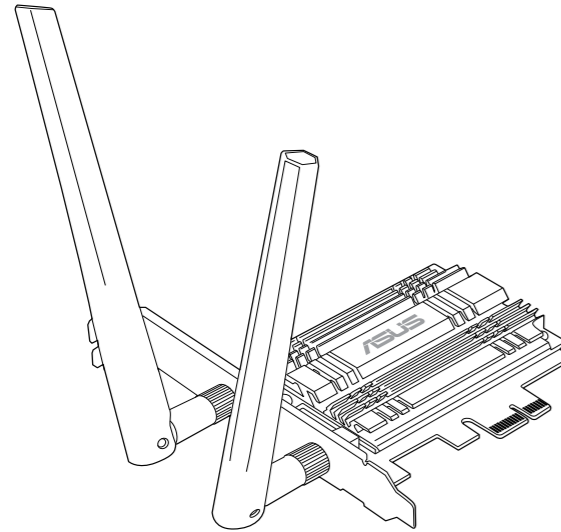

### Quick Start Guide

# Driver installation

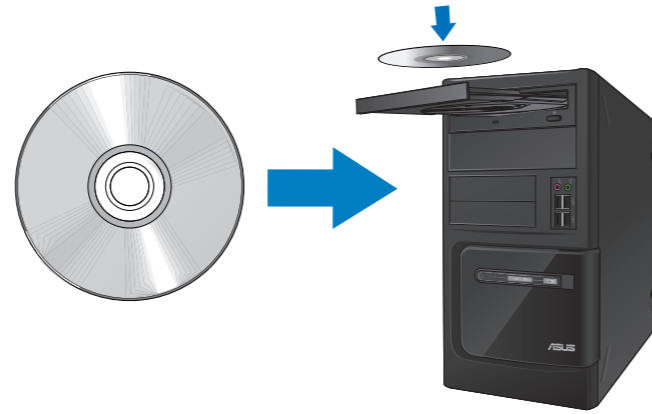

1

Insert the support CD into the optical drive.  
Insérez le CD de support dans votre lecteur optique.  
Inserte el CD de soporte en la unidad óptica.

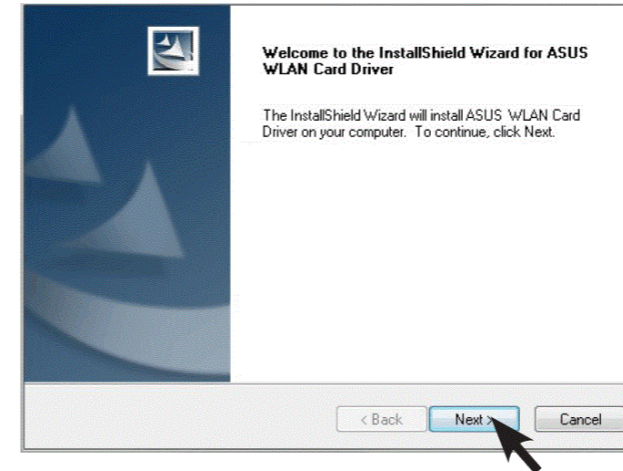

2

Follow the onscreen instructions to complete the installation.  
Suivez les instructions apparaissant à l'écran pour compléter l'installation.  
Siga las instrucciones que aparezcan en la pantalla para completar la instalación.

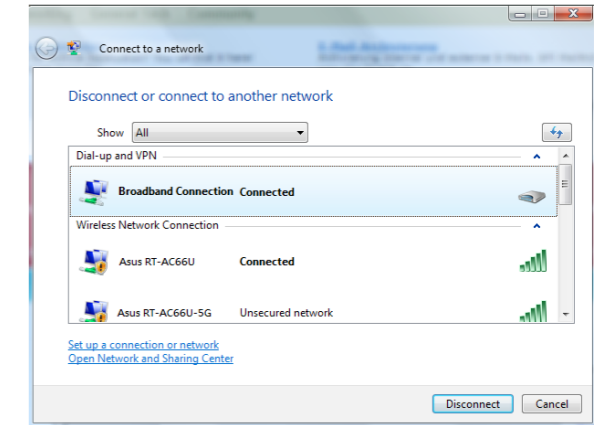

3

When setup is complete, connect your desktop PC to the Internet wirelessly via PCE-AC56.  
Une fois la configuration terminée, connectez votre ordinateur au réseau sans fil par le biais du PCE-AC56.  
Cuando el programa de instalación se complete, conecte su equipo de escritorio a Internet de forma inalámbrica a través de PCE-AC56.

# Setting up a wireless network

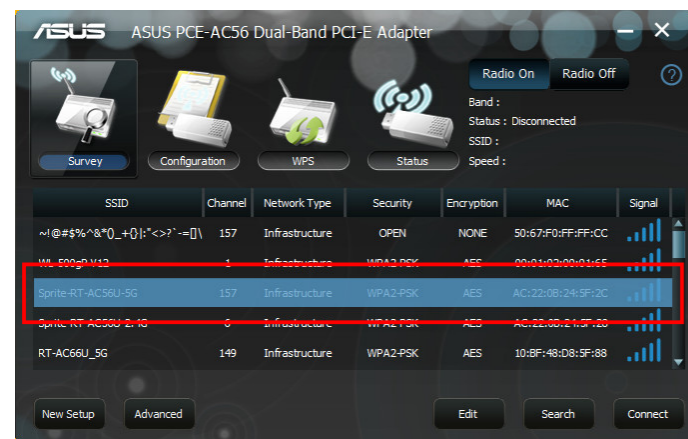

1

Select a wireless network and click Connect.  
Sélectionnez un réseau sans fil et cliquez sur le bouton Connexion.  
Seleccione una red inalámbrica y haga clic en el botón Connect (Conectar).

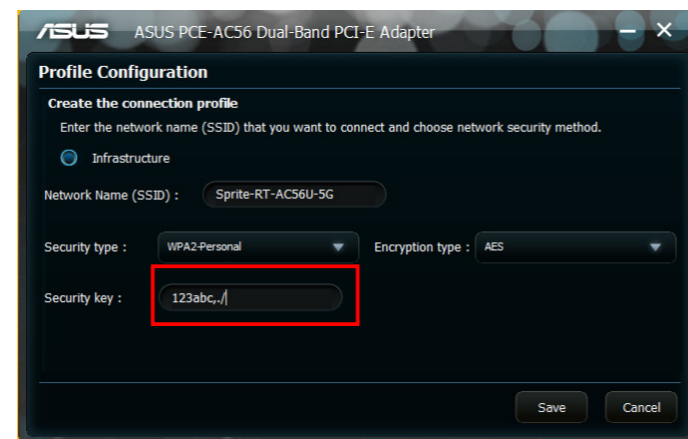

2

Enter the network password.  
Entrez le mot de passe du réseau sans fil.  
Escriba la contraseña de red.

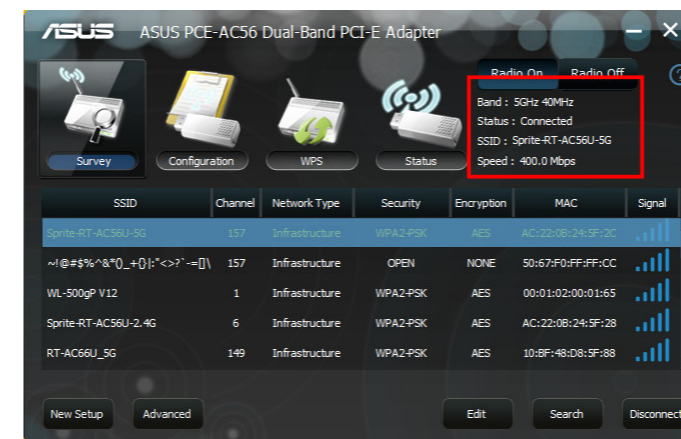

3

Setup complete.  
Configuration terminée.  
Configuración completada.

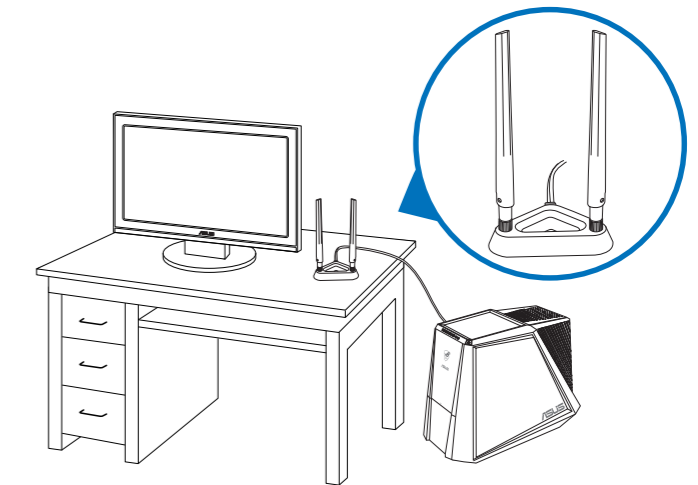

4

Adjust the magnetic antenna base to get the best signal from your router.  
Ajustez la base de l'antenne magnétique pour améliorer la qualité du signal sans fil du routeur.  
Ajuste la base de antena magnética para obtener la mejor señal con su enrutador.

## Federal Communications Commission Statement

This device complies with Part 15 of the FCC Rules. Operation is subject to the following two conditions:

- This device may not cause harmful interference.
- This device must accept any interference received, including interference that may cause undesired operation.

This equipment has been tested and found to comply with the limits for a class B digital device, pursuant to Part 15 of the FCC Rules. These limits are designed to provide reasonable protection against harmful interference in a residential installation.

This equipment generates, uses and can radiate radio frequency energy and, if not installed and used in accordance with the instructions, may cause harmful interference to radio communications. However, there is no guarantee that interference will not occur in a particular installation. If this equipment does cause harmful interference to radio or television reception, which can be determined by turning the equipment off and on, the user is encouraged to try to correct the interference by one or more of the following measures:

- Reorient or relocate the receiving antenna.
- Increase the separation between the equipment and receiver.
- Connect the equipment into an outlet on a circuit different from that to which the receiver is connected.
- Consult the dealer or an experienced radio/TV technician for help.

If this device is going to be operated in 5.15 ~ 5.25GHz frequency range, then it is restricted in indoor environment only.



**CAUTION:** Any changes or modifications not expressly approved by the party responsible for compliance could void the user's authority to operate the equipment.

## Prohibition of Co-location

This device and its antenna(s) must not be co-located or operating in conjunction with any other antenna or transmitter.

## FCC Radiation Exposure Statement

This equipment complies with FCC radiation exposure limits set forth for an uncontrolled environment. This equipment should be installed and operated with minimum distance 20cm between the radiator and your body.

## CE Mark Warning

This is a Class B product, in a domestic environment, this product may cause radio interference, in which case the user may be required to take adequate measures.

Operation Channels: Ch1~11 for N. America, Ch1~14 Japan, Ch1~13 Europe (ETSI)

## 低功率電波輻射性電機管理辦法

(1)「經型式認證合格之低功率射頻電機，非經許可，公司、商號或使用者均不得擅自變更頻率、加大功率或變更原設計之特性及功能」以及(2)「低功率射頻電機之使用不得影響飛航安全及干擾合法通信；經發現有干擾現象時，應立即停用，並改善至無干擾時方得繼續使用。前項合法通信，指依電信法規定作業之無線電通信。低功率射頻電機須忍受合法通信或工業、科學及醫療用電波輻射性電機設備之干擾」。

## Canada, Industry Canada (IC) Notices

This Class B digital apparatus complies with Canadian ICES-003 and RSS-210.

Operation is subject to the following two conditions: (1) this device may not cause interference, and (2) this device must accept any interference, including interference that may cause undesired operation of the device.

## Radio Frequency (RF) Exposure Information

The radiated output power of the ASUS Wireless Device is below the Industry Canada (IC) radio frequency exposure limits. The ASUS Wireless Device should be used in such a manner such that the potential for human contact during normal operation is minimized.

This device has been evaluated for and shown compliant with the IC Specific Absorption Rate ("SAR") limits when installed in specific host products operated in portable exposure conditions (antennas are less than 20 centimeters of a person's body).

This device has been certified for use in Canada. Status of the listing in the Industry Canada's REL (Radio Equipment List) can be found at the following web address: <http://www.ic.gc.ca/app/sitt/relet/srch/nwRdSrch.do?lang=eng>

Additional Canadian information on RF exposure also can be found at the following web: <http://www.ic.gc.ca/eic/site/smt-gst.nsf/eng/sf08792.html>

## Canada, avis d'Industry Canada (IC)

Cet appareil numérique de classe B est conforme aux normes canadiennes ICES-003 et RSS-210.

Son fonctionnement est soumis aux deux conditions suivantes : (1) cet appareil ne doit pas causer d'interférence et (2) cet appareil doit accepter toute interférence, notamment les interférences qui peuvent affecter son fonctionnement.

## Informations concernant l'exposition aux fréquences radio (RF)

La puissance de sortie émise par l'appareil de sans fil ASUS est inférieure à la limite d'exposition aux fréquences radio d'Industry Canada (IC). Utilisez l'appareil de sans fil ASUS de façon à minimiser les contacts humains lors du fonctionnement normal.

Ce périphérique a été évalué et démontré conforme aux limites SAR (Spécific Absorption Rate – Taux d'absorption spécifique) d'IC lorsqu'il est installé dans des produits hôtes particuliers qui fonctionnent dans des conditions d'exposition à des appareils portables (les antennes se situent à moins de 20 centimètres du corps d'une personne).

Ce périphérique est homologué pour l'utilisation au Canada. Pour consulter l'entrée correspondant à l'appareil dans la liste d'équipement radio (REL - Radio Equipment List) d'Industry Canada rendez-vous sur:

<http://www.ic.gc.ca/app/sitt/relet/srch/nwRdSrch.do?lang=eng>

Pour des informations supplémentaires concernant l'exposition aux RF au Canada rendez-vous sur : <http://www.ic.gc.ca/eic/site/smt-gst.nsf/eng/sf08792.html>

## REACH

Complying with the REACH (Registration, Evaluation, Authorisation, and Restriction of Chemicals) regulatory framework, we published the chemical substances in our products at ASUS REACH website at <http://csr.asus.com/english/REACH.htm>.

## Hot Products



### RT-AC68U

- The world's fastest Wi-Fi router with combined dual-band data rates of 1900 Mbps for performance that is 3X faster than 802.11n routers.
- Broadcom® TurboQAM™ technology increases wireless-N data rate to 600Mbps for 33% faster performance
- Five Gigabit Ethernet ports for fast, stable wired network connections
- Dual-core processor for fast and responsive performance with Wi-Fi, Ethernet and USB devices



### RT-AC66U

- 5th generation 802.11ac chipset offers you concurrent dual-band 2.4GHz/5GHz with up to 1.75Gbps connection speed
- AiRadar optimizes wireless coverage with detachable high-powered antennas
- File sharing, printer sharing and 3G sharing via two multi-functional built-in USB ports

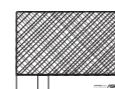

### RT-AC56U

- 802.11ac Dual-Band Wireless-AC1200 Gigabit Router
- AiRadar optimizes wireless coverage with detachable high-powered antennas
- USB3.0 plus USB2.0 ports for file, 3G/4G and printer sharing



### EA-N66

- Powerful dual-band 3x3 Ethernet adapter delivers extreme 450Mbps Wi-Fi speed
- Selectable 2.4GHz/ 5GHz dual-band reduces Wi-Fi interference for HD multimedia
- Patented Orthogonal antenna design for best Wi-Fi coverage
- 3-in-1 function: Ethernet adapter, universal repeater, and AP mode



### DSL-N55U

- Integrated home gateway with independent CPUs for modem and router
- Dual-band Wi-Fi delivers up to 600Mbps in bandwidth
- 4x Gigabit Ethernet ports provide enhanced wired network performance
- Finest P2P experience via 300,000 concurrent data sessions
- File sharing, printer sharing and iPad charging using multi-functional twin USB ports



### RT-N56U

- Concurrent Dual-band - two 300Mbps Wireless-N networks at one time
- Gigabit Ethernet ports for the fastest and most reliable Internet performance
- 5X faster Gigabit Internet surfing with hardware NAT
- File sharing, printer sharing and 3G sharing via two multi-functional built-in USB ports



### RT-N53

- Concurrent Dual Band - two 300Mbps Wireless-N networks at one time
- Guest Network Access - Four separated wireless networks on the 2.4GHz band with customized security and access restrictions
- Easy Universal Repeater - Extend your Parent AP in the fastest and most intuitive way
- ASUSWRT Dashboard UI for easy setup, signal monitoring and network application control



### RT-N66U

- 2.4GHz and 5GHz concurrent dual-band transmissions for strong signal strength and ultra-fast connection rates up to 900Mbps
- Gigabit Ethernet ports for faster, most reliable Internet performance
- Expanded wireless coverage with detachable high-powered antennas

## Manufacturer

ASUSTeK Computer Inc.

Tel: +886-2-2894-3447

Address: No. 150, LI-TE RD., PEITOU, TAIPEI 112, TAIWAN

## Authorised representative in Europe

ASUS Computer GmbH

Address: HARKORT STR. 21-23, D-40880 RATINGEN, DEUTSCHLAND

## Authorised distributors in Turkey

BOGAZICI BIL GISAYAR SAN. VE TIC. A.S.

Tel: +90 212 3311000

Address: AYAZAGA MAH. KEMERBURGAZ CAD. NO.10 AYAZAGA/ISTANBUL

CIZGI Elektronik San. Tic. Ltd. Sti.

Tel: +90 212 3567070

Address: CEMAL SURURI CD. HALIM MERIC IS MERKEZI

No: 15/C D:5-6 34394 MECIDIYEKOY/ISTANBUL

EEE Yönetmeliğine Uygundur.